



Fascetta completa montata

- Queste fascette costituite da due parti permettono di risparmiare il 50% del volume di stoccaggio e di trasporto in rapporto alle fascette costituite da una parte.
- Queste fascette sono state « fosfatate » prima della verniciatura. Questo protegge l'acciaio dalla corrosione e favorisce la presa della vernice.



Fissaggio della cinghia sul supporto Nylstop M12

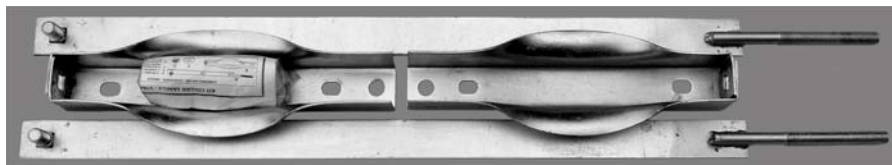

KIT completo = 2 cinghie + 2 supporti + 2 rondelle piatte + 2 dadi Nylstop M12 + 4 dadi Standard M12 + 1 Manuale di istruzioni per il montaggio.

Vendute in kit da due fascette. Acciaio, spessore 2 mm « fosfato » e rivestito con vernice nera opaca o elettrozincato. Fascetta a « CINGHIA » in due parti, venduta in KIT da due fascette in confezione di plastica: 2 Cinghie + 2 Supporti + 4 dadi standard M12 + 2 rondelle piatte + 2 dadi NYLSTOP M12 + un manuale con istruzioni di montaggio.

Kit di protezione GOMMA v. dettagli a pag. 4 e 15	
Permette il rispetto della Norma 87/404/CE	
Rif. ALK	Diam. Fascetta
93.206.00	206
93.000.00	246
	276
	310
93.396.00	396

2 Dadi Standard M12

Confezione da 4 dadi supplementari	
STANDARD M12 Rif. ALK	Filettatura
78.200.00	M12
NYLSTOP M12 Rif. ALK	Filettatura
78.300.00	M12

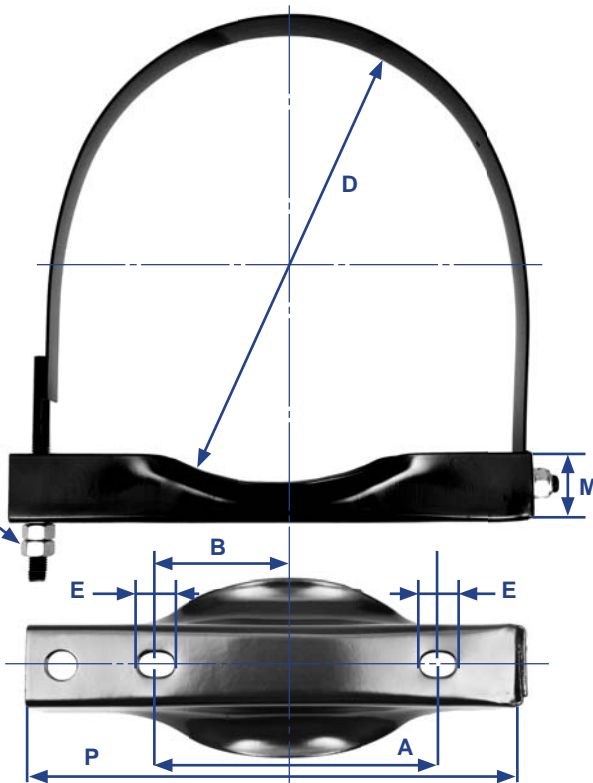

Rif. ALK Nero opaco	Rif. ALK Elettrozincato	Serbatoio Diametro = D	A	B	M	P	E
97.206.00	97.206.00Z	206	130	65	43	229	11x16
97.246.00	97.246.00Z	246	180	90	43	269	11x16
97.276.00	97.276.00Z	276	180	90	43	299	11x16
97.310.00	97.310.00Z	310	200	100	43	333	11x16
97.396.00	97.396.00Z	396	250	125	43	419	11x16
96.206.00	96.206.00Z	206	122	61	43	229	12x16
96.246.00	96.246.00Z	246	162	81	43	269	12x16
96.276.00	96.276.00Z	276	192	96	43	299	12x16
96.310.00	96.310.00Z	310	227	113	43	333	12x16
96.396.00	96.396.00Z	396	307	153	43	419	12x16

Dimensioni in millimetri

D = Diametro esterno del serbatoio in mm

Fascette a « CINGHIA » su due lati

ACCIAIO

Manuale con istruzioni per il montaggio delle fascette a « CINGHIA » in due parti. Queste istruzioni sono presenti in ogni KIT.

KIT COLLIER SANGLE - STRAP SADDLE - SPANNBAND

CONTENU DU KIT - CONTENTS - INHALT

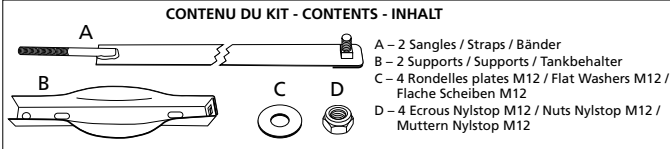

OUTIL NÉCESSAIRE TOOL YOU NEED NOTWENDIGES WERKZEUG

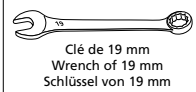

1-Déballer toutes les pièces - Unpacking all the items - Alle Stücke auspacken.

INSTRUCTIONS DE MONTAGE - FITTING INSTRUCTIONS - MONTAGE ANWEISUNGEN

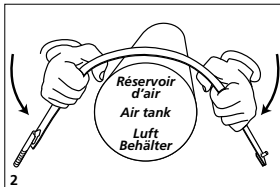

Cintrer les deux sangles "A".
 Bend the two straps "A".
 Die zwei Bänder biegen "A".

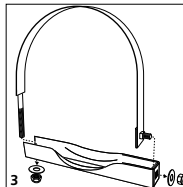

Vérifier le sens de montage.
 Check the way of fitting.
 Den Weg der Montage überprüfen.

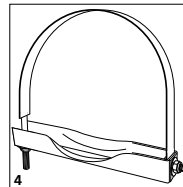

Fixer les sangles "A" sur les Supports "B" avec les rondelles "C" et les écrous Nylstop "D".
 Fit the straps "A" on the supports "B" with the washers "C" and the Nylstop nuts "D".
 Die Bänder "A" auf den Tankbehalter "B" mit den Scheiben "C" und die Muttern Nylstop "D" befestigen.

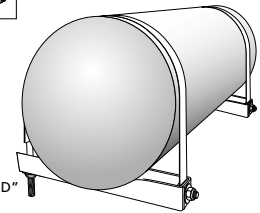
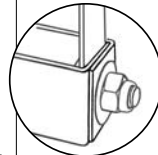

Supporto di una fascetta in due parti



Dettaglio dell'estremità del supporto